

SERIES-VARIOUS AQUAHALO Rain panel - Chrome





41 750 979



- exposed trim parts
- Rain panel with 3 different flow modes
- AQUACIRCLE RAIN: Circular rain curtain, max. flow rate 6.8 l/min (at 3 bar)
- TEMPEST RAIN: Natural rain, max. flow rate 6.8 l/min (at 3 bar)
- DIAMOND RAIN: Ring of rain, max. flow rate 6.8 l/min (at 3 bar)
- Outer diameter: 605 mm, opening diameter: 465 mm
- Weight: 6 kg
- central LED Spot 3000 K
- Protection rating IP67
- Not suitable for use in a steam room.

To meet the North American plumbing standards, this application must be installed with three-way diverter (rough included).

To meet the North American plumbing standards, this application must be installed with three-way diverter (rough included).

	Chrome	41 750 979-00 0010
	Brushed Platinum	41 750 979-06 0010
	Matte Black	41 750 979-33 0010
	Brushed Champagne (22kt Gold)	41 750 979-46 0010
	Champagne (22kt Gold)	41 750 979-47 0010

Required miscellaneous



SERIES-VARIOUS AQUAHALO 35 750 970-00
Concealed ceiling installation box 0010
- Chrome

- concealed rough parts
- Pre-assembly kit for three-way diverter included
- Ceiling installation enclosure 605 x 605 x 95 mm
- Weight: 10 kg
- min. recess depth 110 mm

SERIES-VARIOUS AQUAHALO Rain panel - Chrome

41 750 979

mm [inches]
1:10

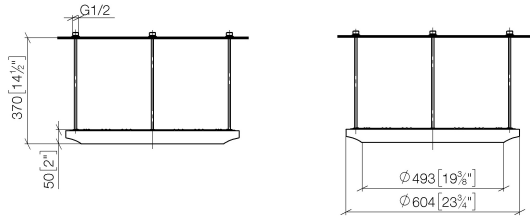

SERIES-VARIOUS AQUAHALO Rain panel - Chrome

41 750 979

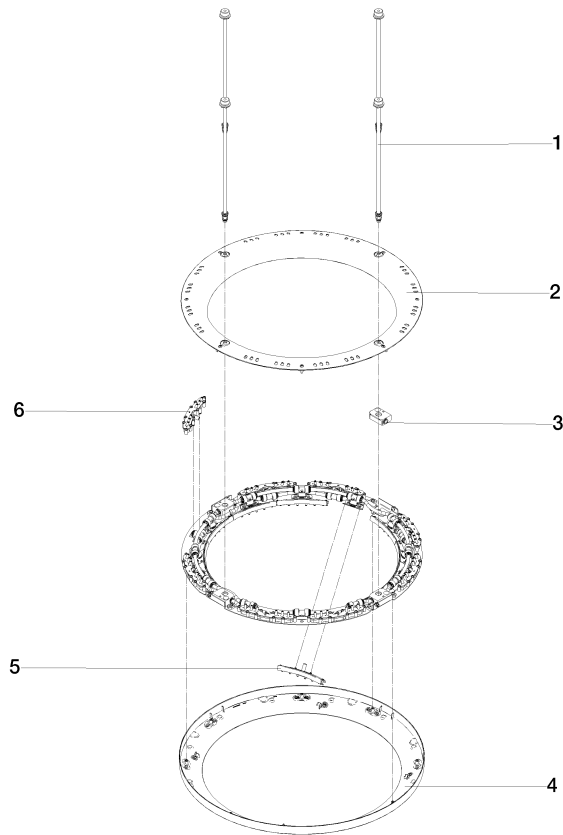

Spare parts list

No.	Item Number	Name	Quantity used	Delivery time
1	90 28 22 605 01-00	distributor	1	10
2	90 12 05 087 00-00	casing	1	10
3	90 24 03 535 00 90	distributor	1	10
4	90 12 05 088 00-00	casing	1	10
5	90 17 09 060 02 90	jet module AQUACIRCLE	1	2
6	90 17 09 061 01 90	jet module TEMPEST	8	2